

**1.**

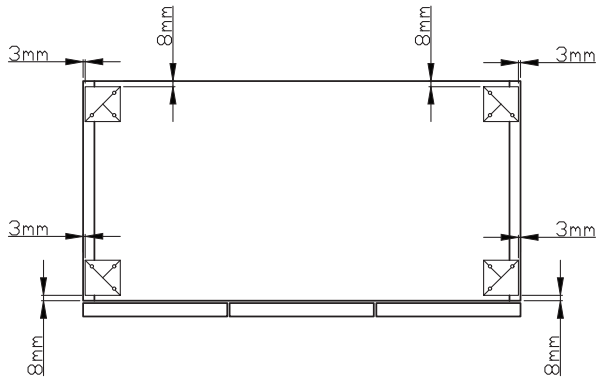

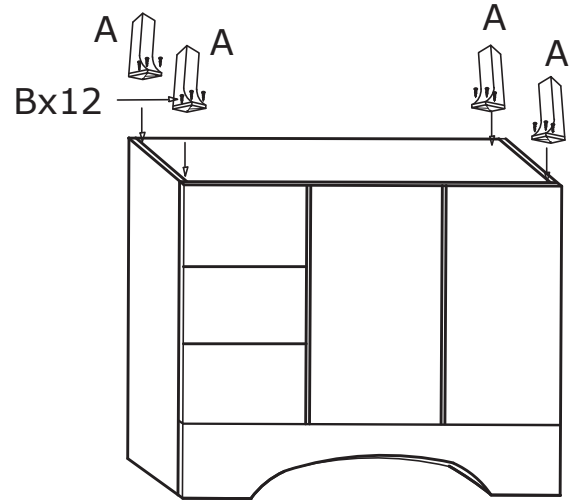



**2.**

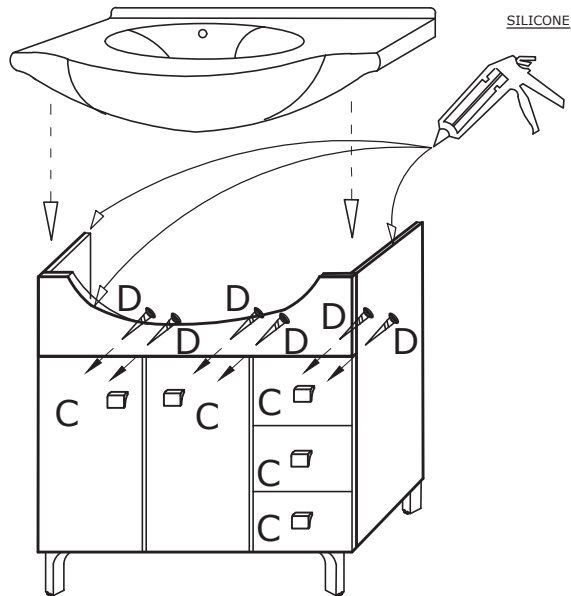

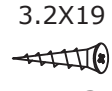

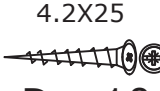
**3.**

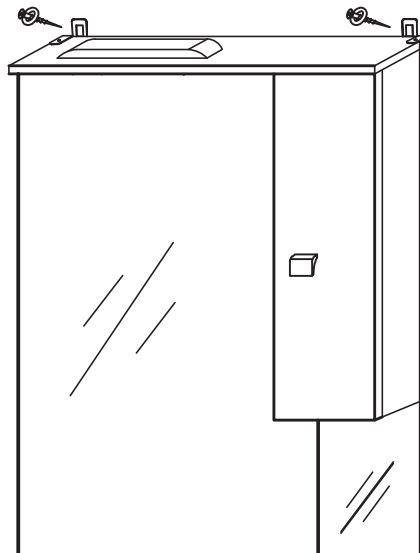
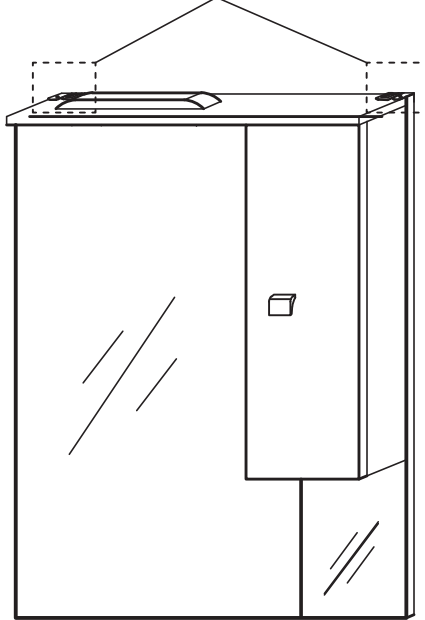
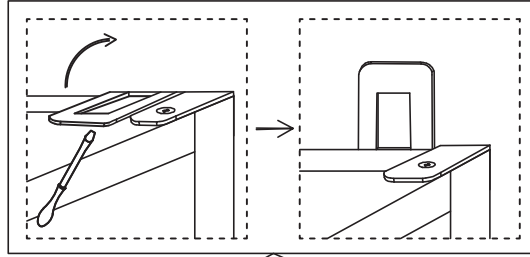

 A x 4	 Bx12	 C x 5	 D x 10			
--	---	--	---	--	---	---

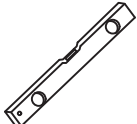
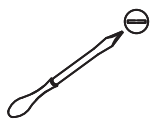
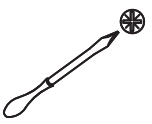

 C x 1	 4.2X25 D x 2			
--	--	---	--	---